

Download APP



YouTube

ATL400 Quick Installation Guide

First Installation

Install mSD Card, keep contact pins side up, and insert with arrow angle

*Format mSD card before use.

*Seal battery cover firmly to avoid from moisture damage, or will be considered as a human cause factor which not covered by warranty.

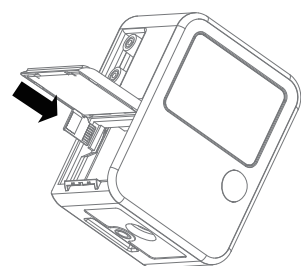

Install Camera Battery(AA*4pcs) .

*Lithium battery or any battery voltage higher than 1.7 volts are not recommended.

*Diameter larger than 14mm are not recommended.

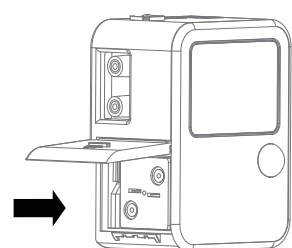

Push the power button until you hear the beep

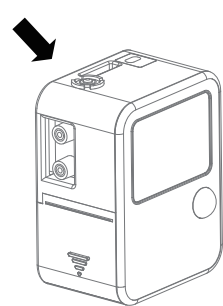

Insert desiccant sheets into the bottom gap
Renew desiccant sheet before recording

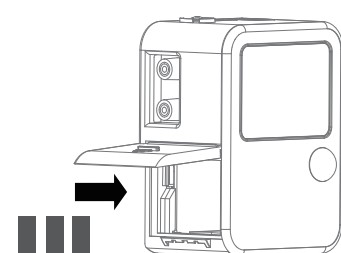

Camera Parts

Shutter & Power Button

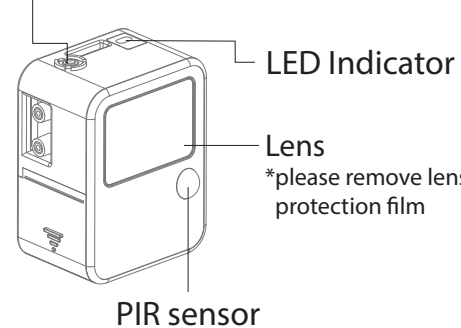

Micro USB Socket Strap Eyelet
*Power input: DC5V 1A

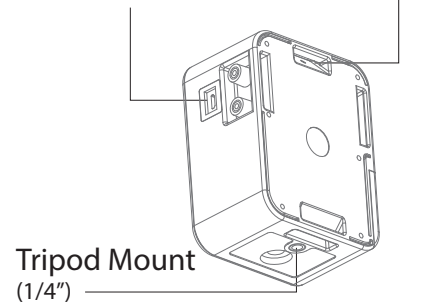

Connecting

On your phone setting

Step 1: Turn on your mobile phone WI-FI. In WI-FI SSID select the time lapse camera

ATL400_XXXXXXXXXX. Default password is 12345678

Step 2. Open Afidus TLC APP. Click "Access control page"

icon to connect with the ATL400

Step 3: Set up camera parameter and enjoy time lapse after click "Record"

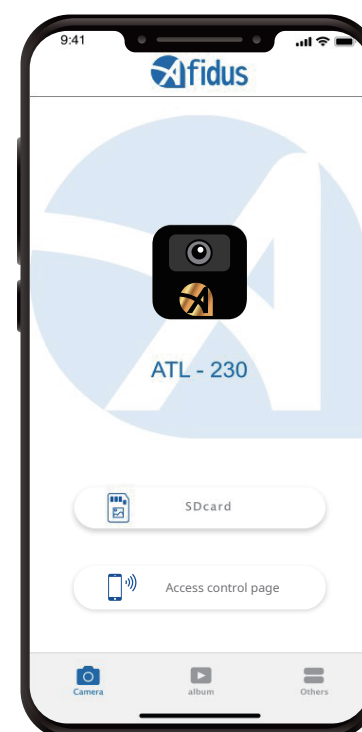

Step 2

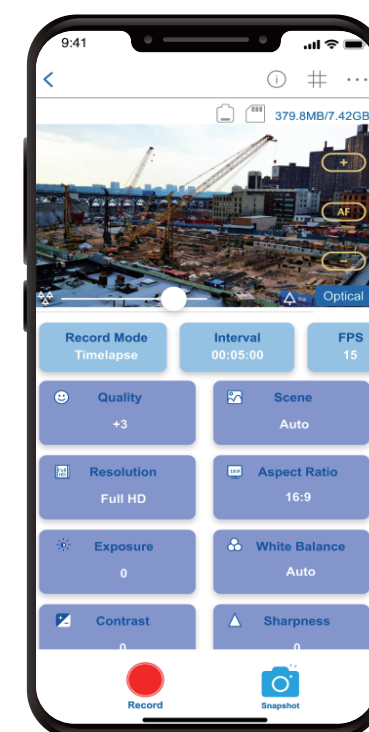

Step 3

Main Screen:

Camera
Connect your smartphone with Afidus camera

album
Downloaded time lapse video/snapshot

Others
Firmware info and FAQ

Camera Icons:

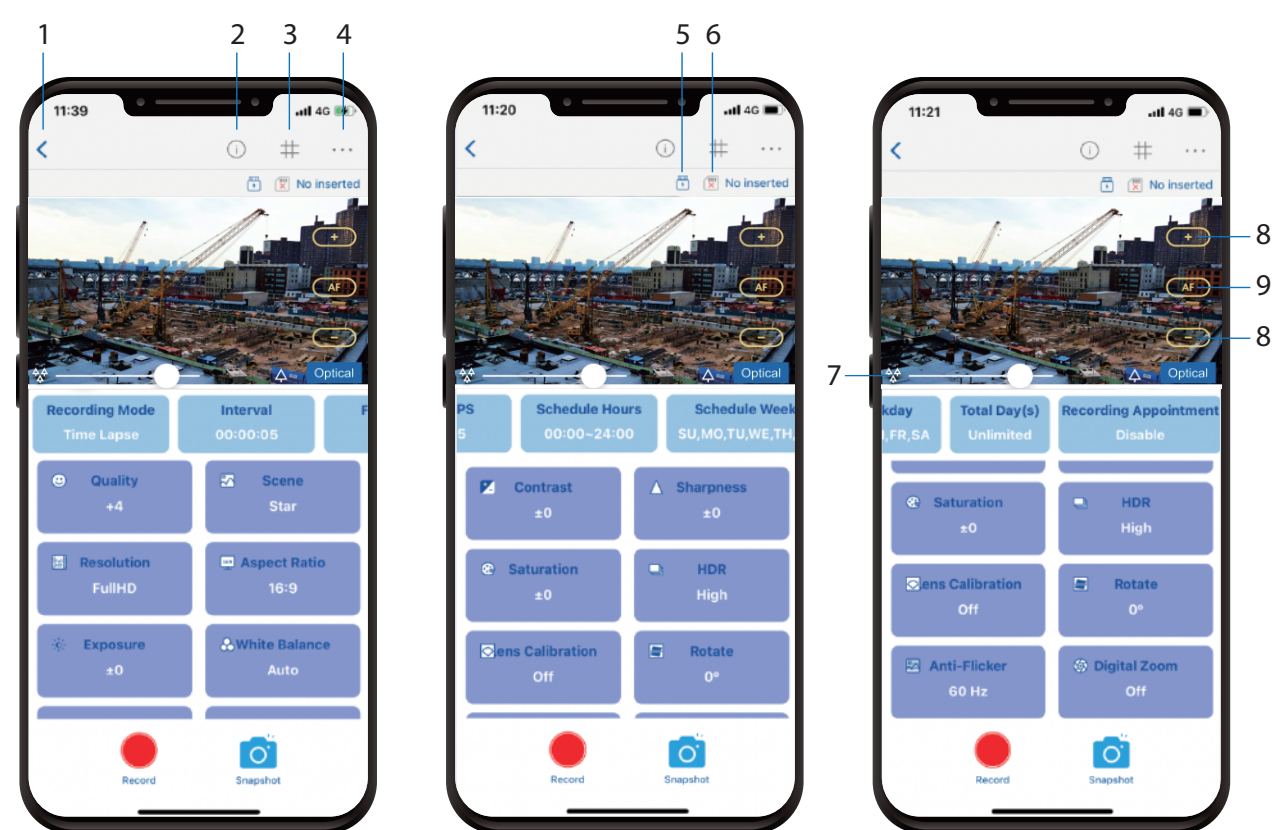

- 1. Home : Back to main page
- 2. Current parameter : Show current parameters
- 3. Grid : 3x3 grid
- 4. More Settings : Enter more settings page
- 5. Power supply : Current power supply
- 6. Memory card : Current memory card status
- 7. Zoom : Drag to adjust zoom in/out
- 8. Focus: Tap to adjust focus
- 9. Auto focus : Tap to auto focus

To Start/Stop recording with APP

To Start Recording:

1. Press power button on time lapse camera until you hear a beep and LED green color
2. On smart phone apps, select "access control page" and "record"
3. APP shows current setting, tap "record"
4. Enjoy it instantly

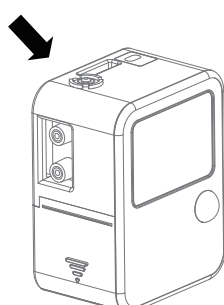

To Stop Recording:

Press power button on time lapse camera for 2 seconds After LED indicator flashes and you hear a beep, recording will stop automatically and time lapse video will be generated immediately

Replay & Download Time Lapse Video from Camera to APP:

1. Open Afidus APP.
2. Tap "SD card" icon.
3. Tap download icon.
4. Video will download to APP.

Download Time Lapse Video from APP to SmartPhone:

1. Tap "Album" icon at homepage.
2. Long press and select file document (Stop Motion, Timelapse, Snapshot)
3. Tap "share" icon and select download.

Share Time Lapse Video:

Tap "share" icon to share videos on social media or to someone through communication APP.

LED Indicator:

Power on: Green
No SD card: Red
Battery Low: Red Flash/6 sec.
Recording: Green/6 sec.
Stop Motion, Timelapse, flash 0.2s

Camera Reset to Default:

- 1: Press reset button (hold), and plug in USB power input (external power input).
- 2: Release power button after hearing (short beep*2 long beep*1).